PRBMD00 Bluetooth 5 ready module

Data sheet version 1.75



Disclaimer

Liability Disclaimer

K-Solution Consulting Co. Ltd reserves the right to make changes without further notice to the product to improve reliability, function or design. K-Solution Consulting Co. Ltd does not assume any liability arising out of the application or use of any product or circuits described herein.

Life Support Applications

K-Solution Consulting Co. Ltd's products are not designed for use in life support appliances, devices, or systems where malfunction of these products can reasonably be expected to result in personal injury. K-Solution Consulting Co. Ltd customers using or selling these products for use in such applications do so at their own risk and agree to fully indemnify K-Solution Consulting Co. Ltd for any damages resulting from such improper use or sale.

Introduction

Base on PHY+ Microelectronics' PHY6212* Bluetooth 5 ready core chip, PRBMD00 BT 5 ready module provides a reliable and easy BT5 solution, allowing user, even without any RF design experience, brings their their product or system, embedded with BT5 feature, to market in time.

Integrated with almost all peripheral components, such as RF matching network, Antenna, 16MHz Crystal, 32768Hz RC, and DC/DC inductor, which saves engineer resource from hardware design for BLE.

PRBMD00 provides a small form factors which is suitable for different applications, with GPIO count, provides high flexibility to user.

PRBMD00 is FCC, CE and Telec certified module, which reduces customer's resource for qualification and allows product to be time to market.

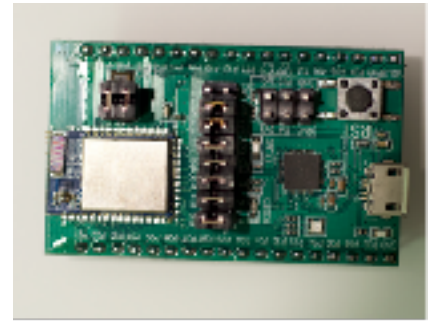
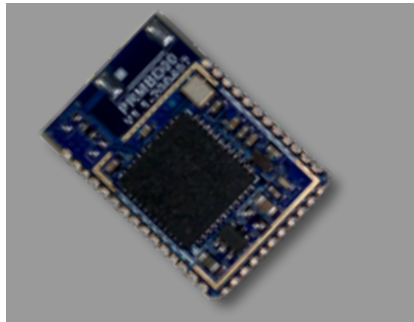
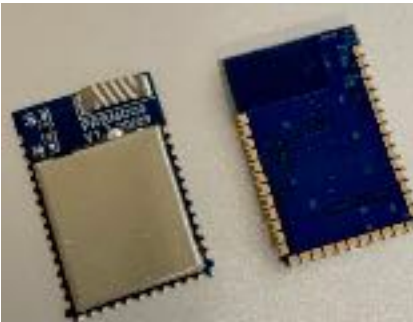

Applications

- Phone accessories
- Computer peripherals
- CE remote controls for TV, STB and media systems
- Beacons
- Proximity and security alert tags
- Sports and fitness sensors
- Healthcare and lifestyle sensors
- Game controllers
- Home Automation
- Smart RF tags for tracking and social interaction

*PHY62xx QDID is 112181

Hardware information

Features

- 32bit Cortex™-M0 processor with 2.4GHz wireless
- On board chip antenna
- On board 16MHz crystal
- Internal 32K RC network
- On board DC/DC converter
- 512KB Flash, 138KB SRAM
- Small form factor: 12 x 18mm
- High GPIOs count : up to 33
- Soft configurable interfaces: PWM (6), I2S (4), PDM (2), I2C (2), SPI (2), UART (1)
- JTAG for debugging
- Up to eight channels 12bit ADC (8)
- Bluetooth v5.0 compliant Protocol Stack (BLE)
- Low power consumption (2 μ A when sleep; 0.7 μ when OFF)
- Supports SIG_Mesh feature: Friend node, Low Power node, Proxy node and Relay node
- Sensitivity up to -103dBm @125Kbps
- Tx power up to +10dBm
- FCC, CE and TELEC certification

Pin assignment

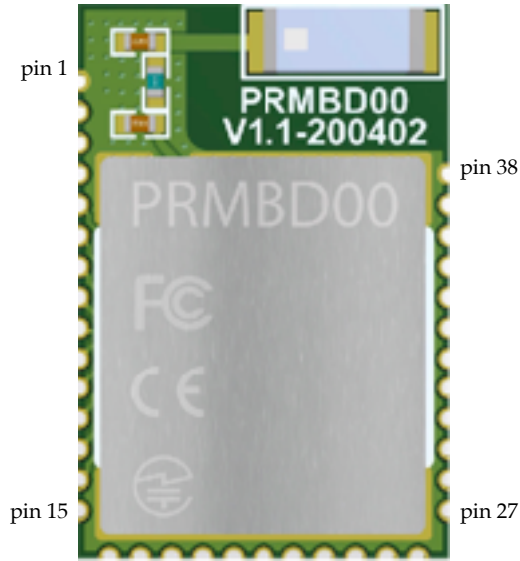

pin	name	Description
1	GND	Power ground
2	P21	GPIO
3	P22	GPIO
4	P23	GPIO
5	P24	GPIO
6	P25	GPIO
7	P26	GPIO
8	P27	GPIO
9	P28	GPIO
10	P29	GPIO
11	P30	GPIO
12	P31	GPIO
13	P32	GPIO
14	P33	GPIO
15	P34	GPIO
16	P00	GPIO
17	P01	GPIO
18	P02	GPIO
19	P03	GPIO
20	P04	GPIO

pin	name	Description
21	P05	GPIO
22	P06	GPIO
23	TM	Mode select, pull high for firmware programming
24	P09	GPIO/UART TX
25	P10	GPIO/UART RX
26	RST	Module power input
27	VDD	VDD, 2.5 to 6V
28	P11	GPIO/AIO0
29	P12	GPIO/AIO1
30	P13	GPIO/AIO2
31	P14	GPIO/AIO3
32	P15	GPIO/AIO4
33	P16	GPIO/32K IN/ AIO5
34	P17	GPIO/32 OUT/ AIO6
35	P18	GPIO/AIO7
36	P19	GPIO/AIO8
37	P20	GPIO/AIO9
38	GND	Power Ground

Dimension

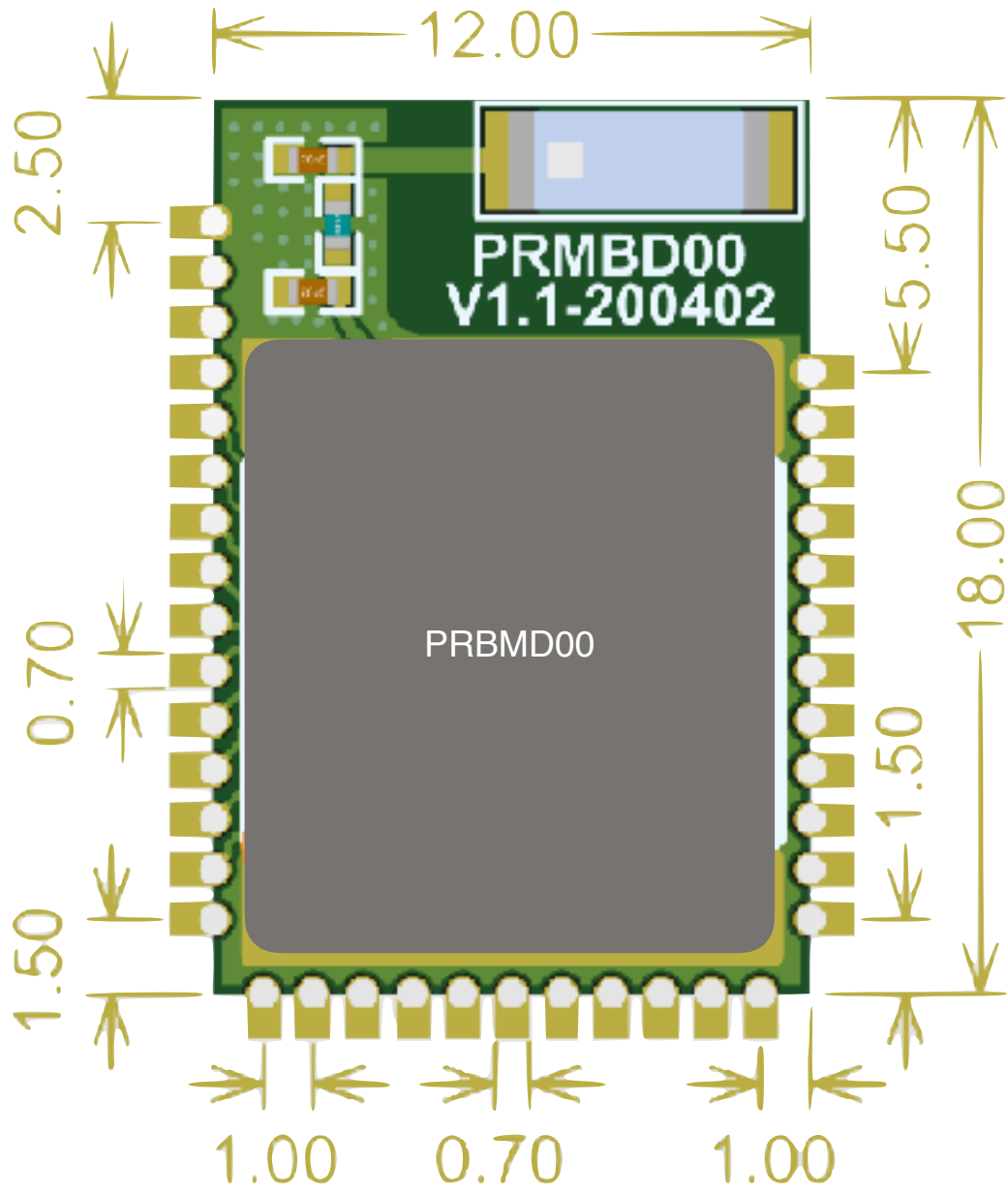

Unit: mm

Electrical Specification

	Description	Typical
General	Operation voltage	2.5V to 6V DC
	Operation current * base on the default firmware	Advertising: Average - 3mA; Max peak - 9mA Connected Average - 3.18mA; Max peak - 9mA
	SLEEP mode current * needed firmware activate	Sleep mode: ~3uA, with 32768Hz RTC
	OFF mode current	0.8uA
	Microcontroller	32-bit ARM Cortex M0
	GPIO	33 configurable
	Oscillators	16MHz crystal oscillator 32kHz RC oscillator (internal)
	Digital I/O	X2 Hardware SPI master UART
	Operation temperature	-10 to 60C
	RF	Frequency band
Modulation		GFSK
Data rate		250kbps, 1 Mbps, 2 Mbps
TX Power		-20 to +10dBm in 4dB steps
Sensitivity		-91dBm Bluetooth low energy -94dBm at 250kb -88dBm at 1Mbs -83dBm at 2Mbs
RF Range (indoor)		50m

Table 1 Electrical Specification

Reset the module

A low signal will reset the module, and the timing is illustrated as following:

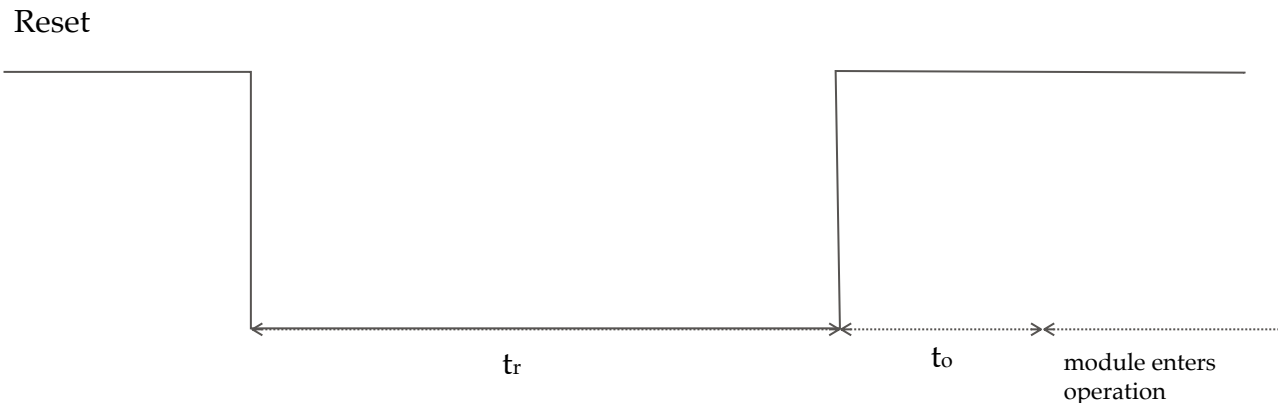

$t_r = \text{at least } 1\mu\text{s}$
 $t_o = 500\mu\text{s}$

The clock

Main clock

PRBMD0x embeds with a 16MHz main oscillator, and it is software configurable up scale to higher internal frequency: 32M, 48M, 64M or 96MHz. By default it is not up scaled.

RTC

If 32.768kHz crystal is not installed (pin P16 and P17), internal RC oscillator circuit can be then enable by firmware and be use as real time clock. This internal RC oscillator circuit will be calibrated periodically. External 32.768KHz circuit is illustrated as below:

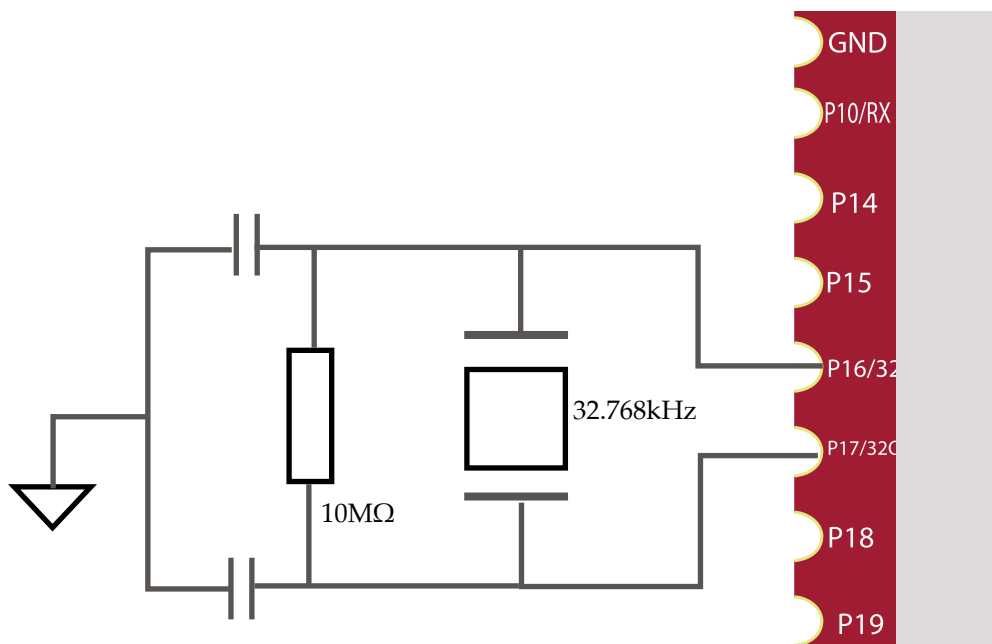

Using external crystal as RTC

Firmware programming

User is able to program their own developed firmware (with SDK) into PRBMD0x. The programming procedure is as following, programming software, PhyPlusKit.exe (for window) must be pre-installed, and UART-USB dongle may be needed:

1. Connect TM pin (pin 10 of PRBMD00; and pin 7 of PRBMD01) to 3.3V
2. Connect Tx and Rx (P09 and P10) pin to UART dongle
3. On PhyPlusKit, select the proper COM port and Baud Rate (default: 115200)
4. Click Erase to erase current firmware in PRBMD00
5. Load the firmware and click Write to program into PRBMD00
6. Connect TM pin to low level and apply reset. New firmware then starts to operate.

GPIO and interfaces

Every GPIO can be configured as Input, Output and Interrupt, and can also be configured as weak pull-up, strong pull-up, weak pull-low or floating mode.

Except ADC, all interfaces are possible to map to different GPIOs by software. The interface including:

1. I2C: it supports 100KHz and 400KHz modes, 7-bit and 10-bit address
2. I2S: either master or slave mode can be enabled
3. UART: Asynchronous Rx/Tx, up to almost 1Mbps, supports parity and 9 bit-data
4. PWM: 6 channels PWM is multiplex with GPIO, and the frequency is base on the main clock (16MHz) as the following equation:

$$\text{Freq_PWM} = 16\text{MHz} / (\text{N_prescaler} \times \text{N_top_count});$$

where the value in N_top_count register controls the frequency

and the Duty cycle is controlled by the following equation:

$$\text{Duty_cycle_PWM} = \text{N_threshold} / \text{N_top_count}$$

where the value in N_threshold, together with N_top_count, control the duty cycle

5. Quadrature decoder: it can interface and decode signal from quadrature-encoded sensor, both mechanical and optical sensors. Input debounce filters is included.
6. Keyscan: it supports up to 16 rows by 18 columns key matrix. Multi-key-press support and de-bounce time is configurable.
- 7.
8. Analog to Digital converter (ADC) : Up to 10 12-bit SAR ADC, and two inputs are with PGA, which provides a software configurable 0 to 42dB with 3dB steps.

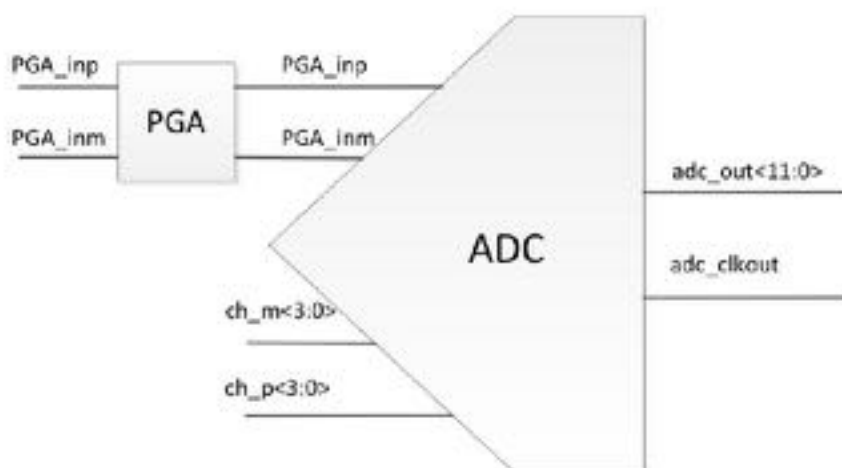

Antenna characteristic

The chip antenna characteristic is illustrated as following:

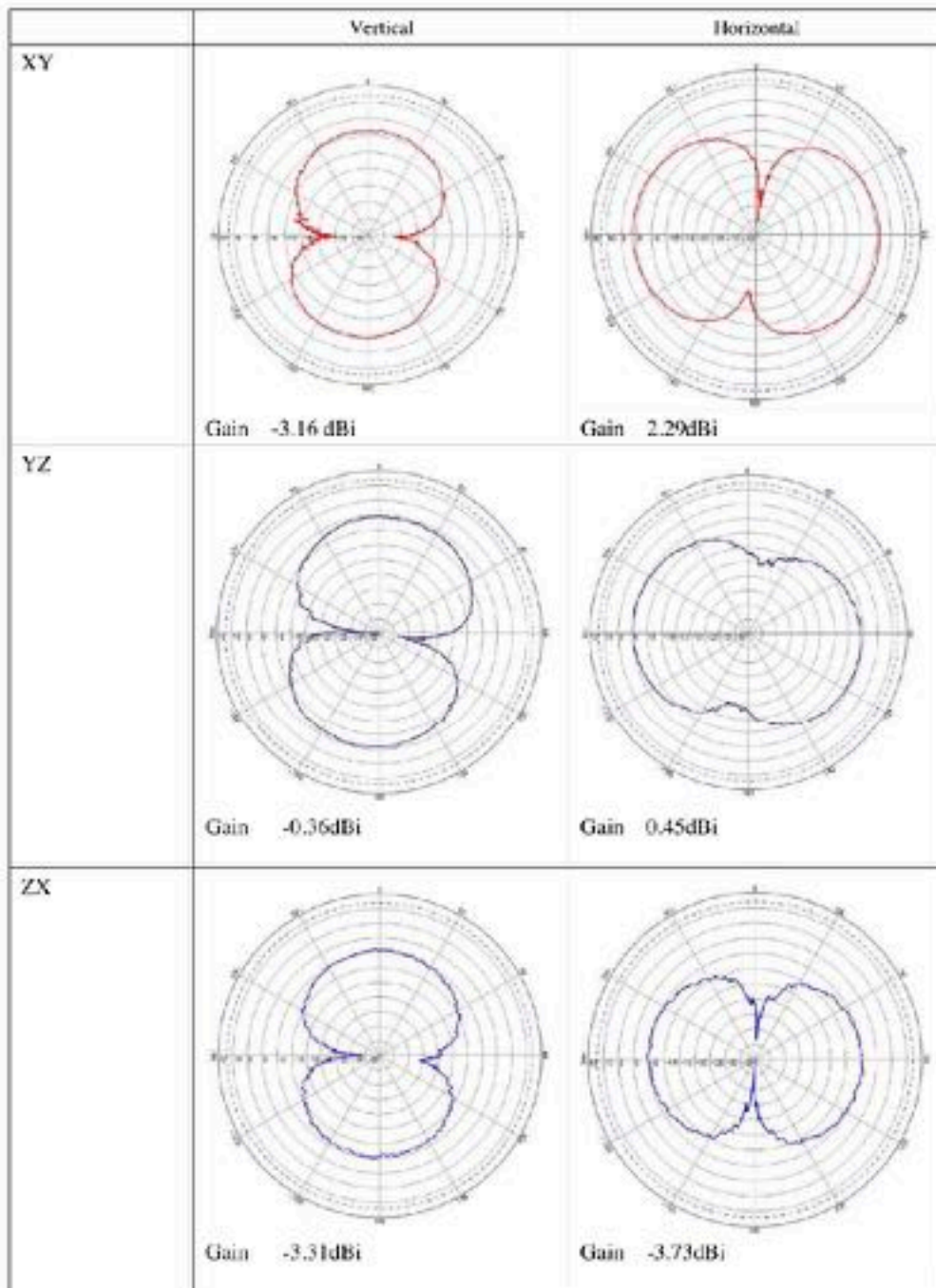

Firmware information

Default firmware

PRBMD00 comes with default UART-BT firmware (firmware name: KATP), allowing user able to enable their product with BT feature without any extra engineer resources. The basic feature of KATP is to tunnel data between UART port Bluetooth device (Transparent mode). User can develop their own firmware by SDK as well.

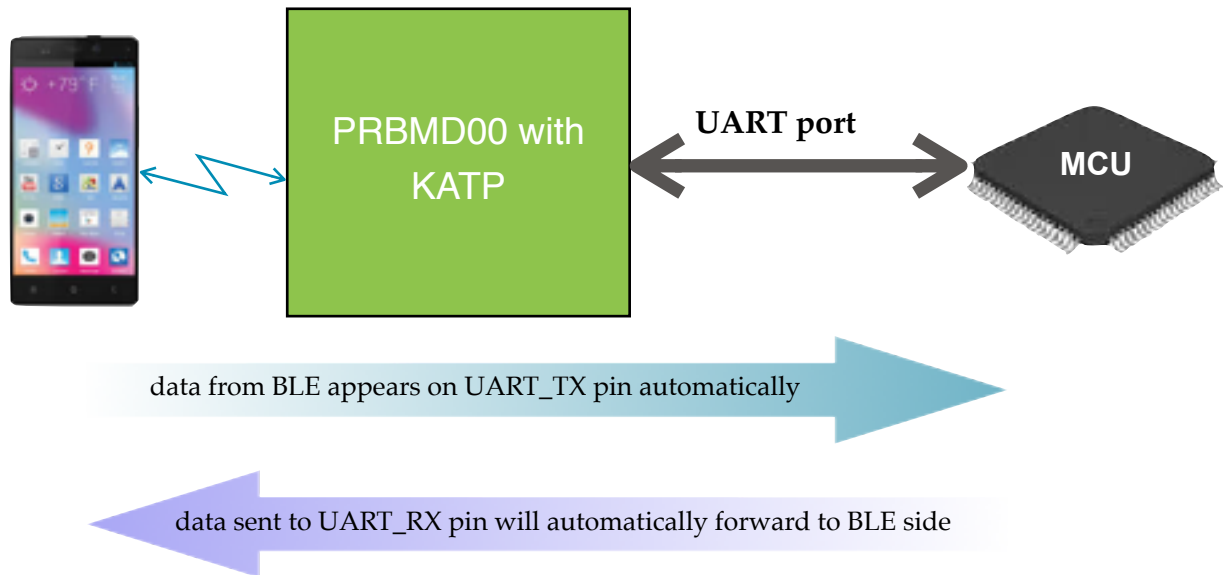

TRANSPARENT mode description

It also provides a AT-CMD mode for configuration:

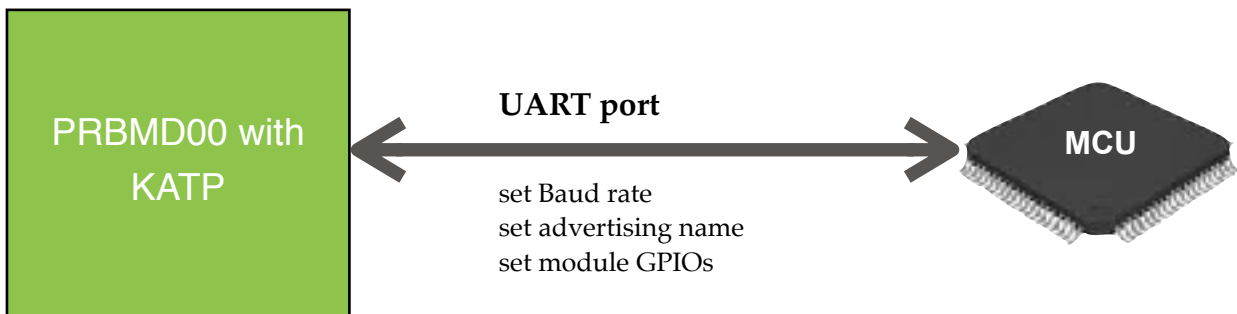

AT-CMD mode description

Sending a test mode command in AT-CMD mode will force KATP to testing mode, which allows user to fix the RF channel and power. Test mode is only for testing or certification purpose only.

Mode selection

KATP will enter either AT-CMD or Transparent mode by the status of MODE_SEL pin (P34) at 10 sec after reset or power up. If the pin is HIGH, PRBMD00 will enter AT-CMD mode, otherwise will enter Transparent mode.

In the 10-sec window, KATP will be at AT-CMD mode first, if command "AT+HIGH" is issue within this window, KATP will then stay at AT-CMD mode after the window period. It provide an alternative way to enter different mode.

In the AT-CMD mode, user is allowed to change settings of PRBMD00, such as UART speed, Bluetooth name...etc. The table below lists all the available AT-CMD.

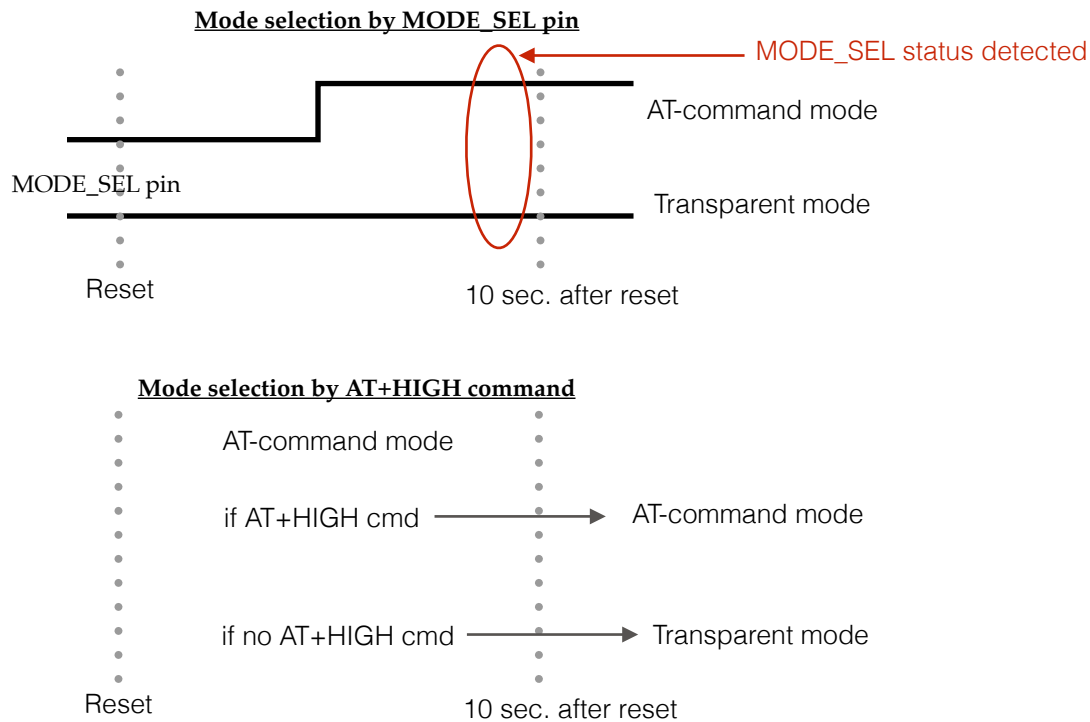

In AT-CMD mode, data can also tunnel between UART and Bluetooth. Any data from Bluetooth side will pass to UART port; Any data not started with "AT+" will be deemed as data and will pass to Bluetooth side.

Default setting

The default setting of KATP are: BUAD=115200; NAME= PRBMD00. User is able to change them in AT-CMD mode. There are two ways to change these setting to default value: 1. AT+DEFAULT command in AT-CMD mode; 2. Pull P03 to ground level while reset or power will also make KATP revert to default setting.

Sleep mode

KATP will put PRBMD00 into sleep mode automatically after a while of idle.

LED indication

KATP uses pin P34 as LED indication (sink), which indicates the connection status. It will flash at the rate of 20ms per second while advertising, and will turn on after connection is built.

Pin P03

Since P03 is assigned two features, mode selection and default value, by KATP, here is a diagram for further description

P03 will be detected at the first 5 sec after reset to determine return-to-default or not, and will determine to enter AT-CMD or Transparent mode at the 10 sec.

Pin assignment

KATP defines pins of PRBMD0 as following:

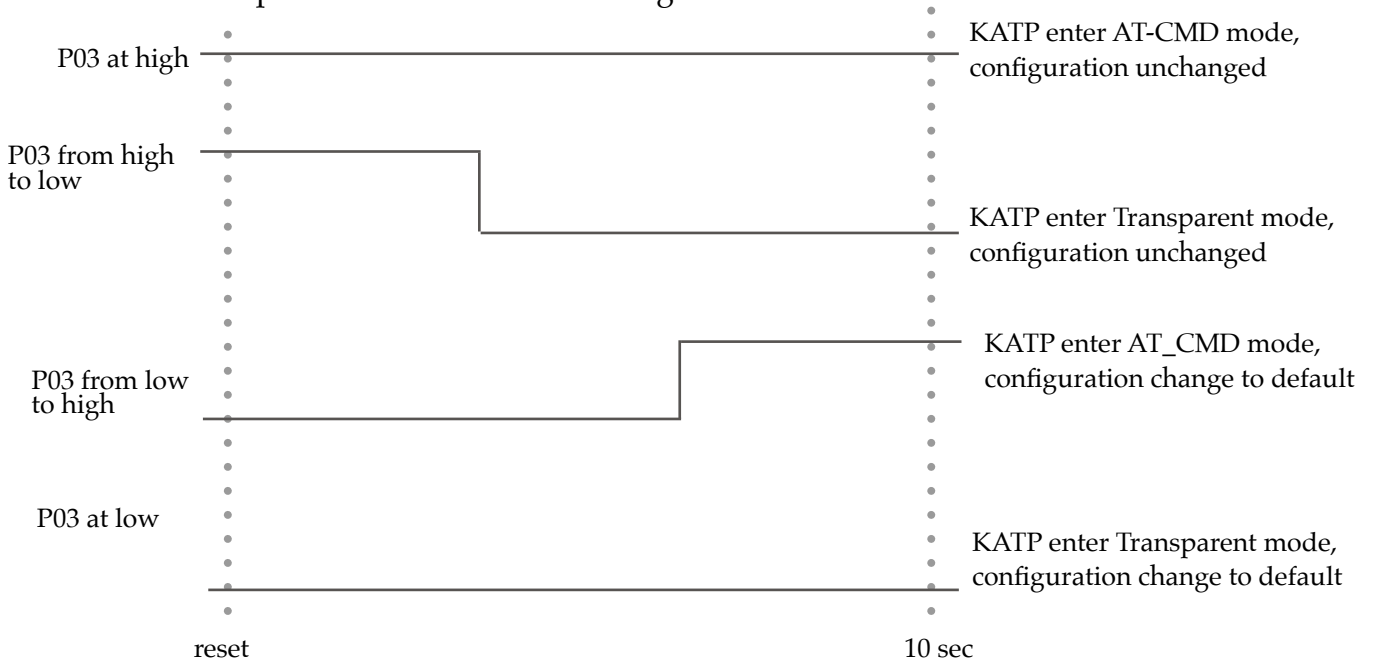

PRBMD00 pin	Function in KATP firmware	Description
P34	BLE_Connect (for LED)	Indicates BT connection: Flash when advertising; Solid when connected
P03	MODE_SEL	Goes to AT-CMD or Transparent mode after reset.
P09	UART_TX	UART transmit - connect to Rx of external device
P10	UART_RX	UART receive - connect to Tx of external device



Pin assignment in PRBMD00

AT-Command list in AT-CMD mode

	Action	enquiry	return value	set	return value
System	MAC addr *	AT+ID?	Current address		
	Help	AT+HELP	All AT commands		
	Reset			AT+RESET	
	Factory Default			AT+DEFAULT	- BAUD = 115200, TXP = 0, NAME = PRBMD00, Flow control disabled
	Exit AT-CMD mode			AT+EXIT - enter transparent mode from AT-CMD	
BLE	Change name	AT+NAME?	- current name Default:PRBMD00	AT+NAME= New name	
	Start advertising			AT+BDCS	
	Stop advertising			AT+BDCE	
UART and GPIO	BAUD rate	AT+SPEED?	Current baud	AT+SPEED=BAUD , BAUD = 2400, 4800, 9600, 14400, 19200, 28800, 38400, 57600, 115200	- New BAUD if success note: data byte, parity and stop bit are fixed at 8,N,1
	Turn P34 off			AT+LEDOFF - turn P34 off; P34 will turn on once it is connected, use this command to turn it off for saving power	
	Read and set IO pin	AT+GPIOxx=? xx:04-33	level of the GPIO pin	AT+GPIOxx=y xx:04-33	y= 0 or 1, where 0 is low level and 1 is high level
RF test	Set all GPIO high			AT+HIGH	
	Set all GPIO low			AT+LOW	
	Fix a Tx channel #			AT+TXa=b a= modulation data, 0: PRBS9 1: 1111000 2: 10101010 b= 0-39 Tx channel i.e.: AT+TX1=20	
	Fix a Rx channel#			AT+RX=c c=0-39 channel	
	TX power	AT+TXP?	Current TX Power value	AT+TXP= p p : -20, -15, -10, -6, -5, -3, 0, 3, 4, 5	- new value

Mounting guide

PRBMD00 is RF sensitive; in order to obtain the best performance, it is recommended to mount the module at corner of mother board, and with some marginal space.

Also, keep it away from metal components, such like speakers, transformers, batteries, big aluminum capacitors, heat sinks and Metal Panels.

The figure below illustrates how to mount the PRBMD00 module. Improper mounting will decrease the RF performance dramatically.

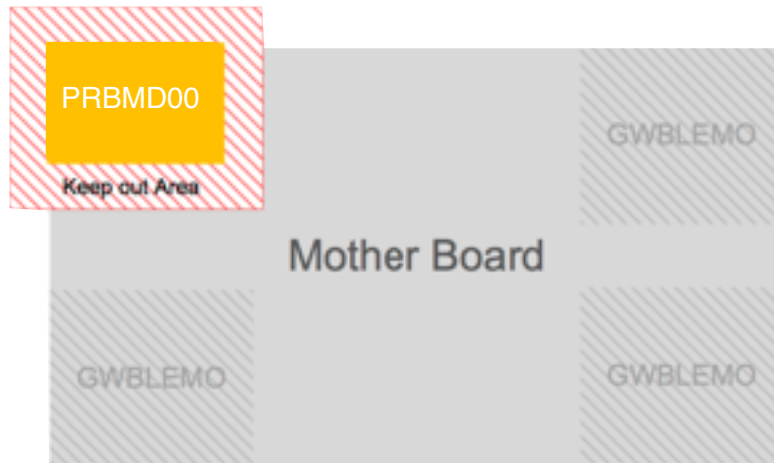

Evaluation Board

Evaluation board (EVB) for PRBMD00 is available, helping engineer for the firmware development. It is in DIP form factor, allows engineer to connect with external circuit easily for debugging and testing.

The EVB is illustrated as following:

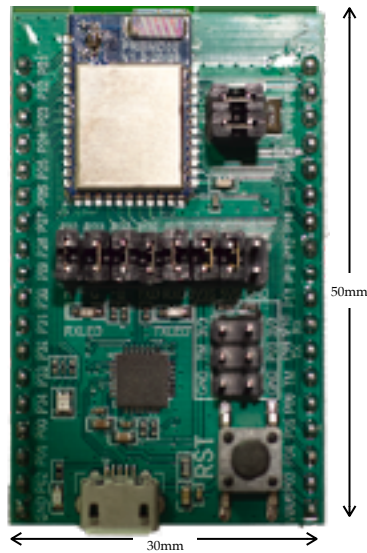

The EVK is in DIP format with PRBMD00 on it, and with on board 32.768KHz crystal and UART-USB chip, allow user to test and program the module easily. PRBMD00 is pre-programmed with the UART-BT tunnelling firmware. Below is the block diagram of the EVK:

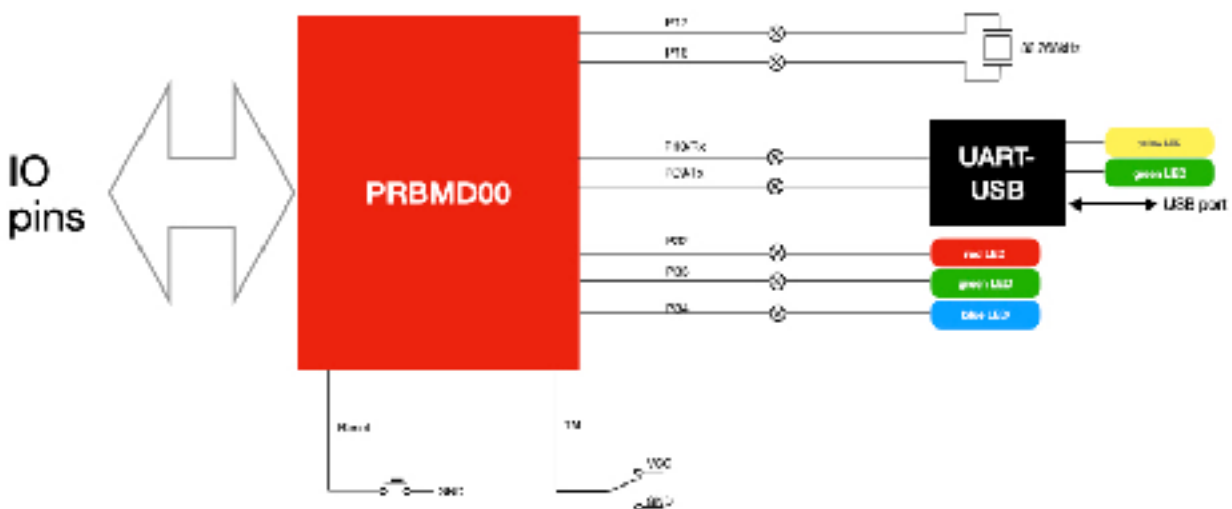

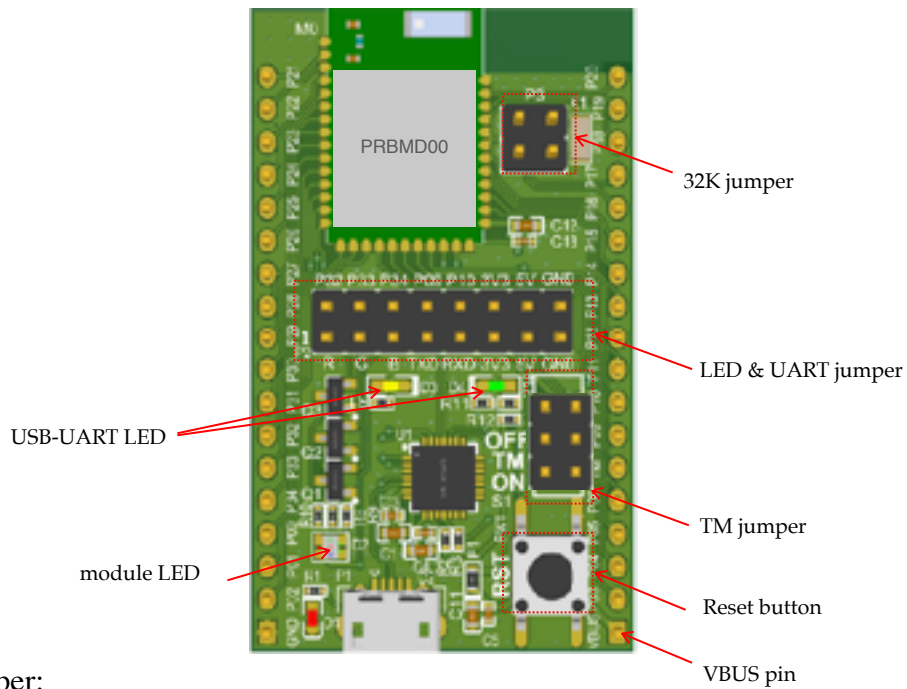

1. 32K jumper:
Since P16,P17 are multiplex with external 32.768KHz oscillator, this jumper allows the PRBMD00 to connected with the on board 32.768KHz oscillator.
2. LED & UART jumper:
This jumper allows the module to connected with on-board LED and the on-board USB-UART chip. Connecting 5V allow PRBMD00 to be powered from USB. Connecting 3V3 will provides a 3.3VDC to the rest of the board
3. TM Jumper
PRBMD00 goes into firmware programming mode if TM pin is connected to the 3V3 pin.
4. Reset button
Pressing this button to reset PRBMD00 module
5. USB-UART LED:
LEDs indicate UART traffic, yellow LED represents TXD and green LED represents RXD
6. module LED:
LEDs connect to the LED & UART jumper, user can makes use of these LED by shorting the jumper.
7. VBus pin:
The EVK can be powered by USB port, or a 5VDC can be applied to this pin to power up the board.

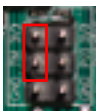
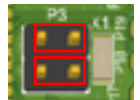

Firmware development and SDK

User is allowed to developed their own firmware for PRBMD00 through SDK as following:

1. copy SDK to a working directory
2. install MDK Keil5 for ARM IDE
3. Example code in SDK can now be edit and compiled.

Experience on ARM core firmware development will be very helpful for development the firmware.

The SDK for PRBMD00 including the following resource:

PHY62XXSDK	
components	; SDK components, including BLE API, GATT profile, drivers and other components
example	; example
ble_central	;
ble_peripheral	;
alternate_iBeacon	; alternate iBeacon example
ancs	; Apple Notification Center Service example
bleI2C_RawPass	; I2S tunnelling example
bleSmartPeripheral	; General peripheral example
bleUart-RawPass	; UART tunnelling example
eddystone	; eddystone example
HIDKeyboard	; HID example
hrs	; Heart rate profile example
iBeacon	; iBeacon example
otaDemo	; Basic OTA example
pwmLight	; example of LED control by PWM, by BLE command
RawAdv	; simple boardcasting example, for tire pressure monitor
Sensor_Broadcast	;
wrist	; General example for sport bracelet
wrist_aptm	; General example, real time timer base on AP Timer + OSAL Timer
XIPDemo	; Example of running within flash, for application not requiring realtime response
OTA	;
OTA_internal_flash	; OTA bootloader
OTA_upgrade_2ndboot	; Special example for upgrading OTA bootloader
peripheral	;
adc	; ADC driver example
ap_timer	; AP timer driving example
fs	; File system example
gpio	; GPIO demo example
kscan	; 4x4 keypad example
lcd_ST7789VW	; 240x240 TFT display example
pwm	; PWM demo example
qdec	; QDEC demo example
spiflash	; SPI ext. device example
voice	; Audio sampling example
voice_sbc	; SBC coding format audio sampling example
watchdog	; Watchdog example
lib	; lib and .h document, including Bluetooth stack and Font library
font	; Font resource document
misc	; ROM symbol table and others

Please contact us for the details of the SDK.

Service

Firmware programming

K-Solution provide pre-programming service, so that PRBMD00 will be shipped with firmware pre-programmed. Service charge is needed.

Software service from K-Solution

K-Solution also provides firmware develop service for PRBMD00 module, hence customer do not need to spend their resource on the firmware development.

These services requires NRE charge. For the details, please contact our local sales representative or distributor.

Hardware design service

K-Solution can also provide circuit design service base on PRBMD00, so that customer can simply focus on the ID of their product.

Circuit board production service

With our partners factory, K-Solution is able to provide SMT-ed PCB with PRBMD00 to customers, and helping customer the assembly their products.

Certification service

K-Solution could introduce our partnered test lab to customer for their product certification, where K-Solution could facilitate the process.

Certifications



TCB

**GRANT OF EQUIPMENT
AUTHORIZATION**

TCB

Certification
Issued Under the Authority of the
Federal Communications Commission
By:

Telefication B.V.
Edisonstraat 12a
Zevenaar, NL-6902 PK
Netherlands

Date of Grant: 12/10/2020

Application
Dated: 12/08/2020

K-Solution Consulting Co. Ltd.
Blk. H, 11/f, Yuet Wah mansion
39 Yuet Wah street, KwunTong
HK,
China

Attention: Au King Shing

NOT TRANSFERABLE

EQUIPMENT AUTHORIZATION is hereby issued to the named
GRANTEE, and is VALID ONLY for the equipment identified herein for
use under the Commission's Rules and Regulations listed below.

FCC IDENTIFIER: 2AX9WMD00
Name of Grantee: K-Solution Consulting Co. Ltd.
Equipment Class: Digital Transmission System
Notes: PRBMD00 EVK
Modular Type: Single Modular

Grant Notes	FCC Rule Parts	Frequency Range (MHz)	Output Watts	Frequency Tolerance	Emission Designator
	15C	2402.0 - 2480.0	0.0023		

Modular Approval. Power output listed is conducted. This grant is valid only when the module is sold to OEM integrators and must be installed by the OEM or OEM integrators. The antennas used for this transmitter as shown in this filing must be installed to provide a separation distance of at least 20 cm from all persons and must not be co-located or operating in conjunction with any other antenna or transmitter. End-users may not be provided with the module installation instructions. OEM integrators and end-users must be provided with transmitter operating conditions for satisfying RF exposure compliance.

Certificate No.: 202181074/AA/00	Ramy Nabed Product Assessor	
-------------------------------------	--------------------------------	---

EU-type examination (Module B) certificate

No: 202140637/AA/00

In compliance with the procedure specified in RD_061, Telefication declares as designated Notified Body 0560 for the European Radio Equipment Directive, that the stated product, complies with the essential requirements, in accordance with Article 3 of Directive 2014/53/EU, as indicated under Annex 1 of this certificate, based on the applicable Technical Standards and Specifications as listed under Annex 2 of this Certificate.

Product description: PRBMD00 EVK
Trademark: K-Solution
Type designation: PRBMD00
Hardware / Software version: V1.1 / 1.0

This certificate is granted to manufacturer:

Name: K-Solution Consulting Co.,Ltd
Address: Bldg. H, 11/F, Yuet Wah mansion, 39 Yuet Wah street, Kwun Tong
City: Hong Kong
Country: China

This certificate remains valid as long as the stated product stays in compliance with the essential requirements of the Radio Equipment Directive.

This certificate has THREE Annexes.

Zevenaar, 09 December 2020



Ramy Nabod
Product Assessor



Certificate of Radio Equipment in JAPAN

No: 201-200930 / 00

Telefication, operating as Conformity Assessment Body (CAB ID Number: 201) with respect to Japan, declares that the listed product complies with the Technical Regulations Conformity Certification of Specified Radio equipment (ordinance of MPT N° 37,1981)

Product description: PRBMD00 EVK
Trademark: K-Solution
Type designation: PRBMD00
Hardware / Software version: V1.1 / 1.0

Manufacturer: K-Solution Consulting Co.,Ltd
Address: Blk. H, 11/F, Yuet Wah mansion, 39 Yuet Wah street, Kwunlong
City: Hong Kong
Country: China

This certificate is granted to:

Name: K-Solution Consulting Co.,Ltd
Address: Blk. H, 11/F, Yuet Wah mansion, 39 Yuet Wah street, Kwunlong
City: Hong Kong
Country: China

This certificate has THREE Annexes.

Zevensaar, 09 December 2020

CAB



David Chen
Product Assessor



Conformity

FCC regulatory conformance :

This device complies with Part 15 of the FCC Rules. Operation is subject to the following two conditions:

- (1) This device may not cause harmful interference.
- (2) This device must accept any interference received, including interference that may cause undesired operation.

NOTE: This equipment has been tested and found to comply with the limits for a Class B digital device, pursuant to part 15 of the FCC Rules. These limits are designed to provide reasonable protection against harmful interference in a residential installation.

This equipment generates uses and can radiate radio frequency energy and, if not installed and used in accordance with the instructions, may cause harmful interference to radio communications. However, there is no guarantee that interference will not occur in a particular installation. If this equipment does cause harmful interference to radio or television reception, which can be determined by turning the equipment off and on, the user is encouraged to try to correct the interference by one or more of the following measures:

- Reorient or relocate the receiving antenna.
- Increase the separation between the equipment and receiver.
- Connect the equipment into an outlet on a circuit different from that to which the receiver is connected.
- Consult the dealer or an experienced radio/TV technician for help

NOTE: The manufacturer is not responsible for any radio or TV interference caused by unauthorized modifications to this equipment. Such modifications could void the user's authority to operate the equipment.

RF Exposure

This equipment complies with FCC radiation exposure limits set forth for an uncontrolled environment.

ORIGINAL EQUIPMENT MANUFACTURER (OEM) NOTES

The OEM must certify the final end product to comply with unintentional radiators (FCC Sections 15.107 and 15.109) before declaring compliance of the final product to Part 15 of the FCC rules and regulations. Integration into devices that are directly or indirectly connected to AC lines must add with Class II Permissive Change.

The OEM must comply with the FCC labeling requirements. If the module's label is not visible when installed, then an additional permanent label must be applied on the outside of the finished product which states: "Contains transmitter module FCC ID: **2AX9WMD00**". Additionally, the following statement should be included on the label and in the final product's user manual: "This device complies with Part 15 of the FCC Rules. Operation is subject to the following two conditions:

- (1) This device may not cause harmful interferences, and
- (2) this device must accept any interference received, including interference that may cause undesired operation."

The module is limited to installation in mobile or fixed applications. Separate approval is required for all other operating configurations, including portable configuration with respect to Part 2.1093 and different antenna configurations.

A module or modules can only be used without additional authorizations if they have been tested and granted under the same intended end - use operational conditions, including simultaneous transmission operations. When they have not been tested and granted in this manner, additional testing and/or FCC application filing may be required. The most straightforward approach to address additional testing conditions is to have the grantee responsible for the certification of at least one of the modules submit a permissive change application. When having a module grantee file a permissive change is not practical or feasible, the following guidance provides some additional options for host manufacturers. Integrations using modules where additional testing and/or FCC application filing(s) may be required are: (A) a module used in devices requiring additional RF exposure compliance information (e.g., MPE evaluation or SAR testing); (B) limited and/or split modules not meeting all of the module requirements; and (C) simultaneous transmissions for independent collocated transmitters not previously granted together.

This Module is full modular approval, it is limited to OEM installation ONLY.

Integration into devices that are directly or indirectly connected to AC lines must add with Class II Permissive Change. (OEM) Integrator has to assure compliance of the entire end product include the integrated Module. Additional measurements (15B) and/or equipment authorizations (e.g. Verification) may need to be addressed depending on co-location or simultaneous transmission issues if applicable. (OEM) Integrator is reminded to assure that these installation instructions will not be made available to the end user

Operating Frequency : (Bluetooth LE) 2402-2480MHz
RF output power(Max) : 4dBm

Manufacturer information:

Company name: K-Solution Consulting Co. Ltd

Address : Blk. H, 11/f, Yuet Wah mansion, 39 Yuet Wah street, KwunTong, HK

CAUTION :

1. EUT Temperature: 0°C ~ +50°C.
2. Input: DC 3.3V
3. The device complies with RF specifications when the device used at 5 mm from your body, and the holder must not be of metal composition.

RF exposure information: The EIRP power of the device at maximal case is below the exempt condition, 20mW specified in EN62479: 2010. RF exposure assessment has been performed to prove that this unit will not generate the harmful EM emission above the reference level as specified in EC Council Recommendation(1999/519/EC).

Hereby, K-Solution Consulting Co. Ltd. declares that the radio equipment type PRBMD00 is in compliance with Directive 2014/53/EU. The full text of the EU declaration of conformity is available at the following internet address: www.k-sol.com.hk

Ordering part number

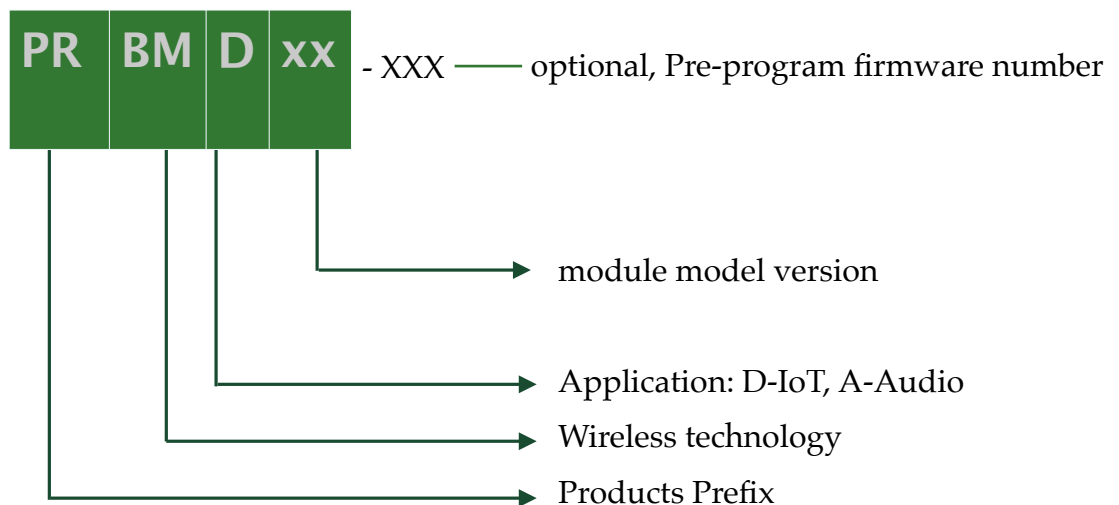

Available part number:

PRBMD00 - PHY6212 core BT5 module, on board chip antenna, 38 pins, 12 x 18 mm, standard UART firmware, chip antenna, metal shielding and certifications

PRBMD01 - PHY6212 core BT5 module, on board chip antenna, 24 pins, 10 x 14 mm standard UART firmware, chip antenna, no metal shielding and no certification

PRBMD02 - PHY6222 core BT5 module, 10 x 14 mm, standard UART firmware, chip antenna, metal shielding and certifications

PRBMD12 - PHY6222 core BT5 module, 10 x 14 mm, standard UART firmware, PCB antenna.

PRBMDEVK - Evaluation board with PRBMD00 on board

Label

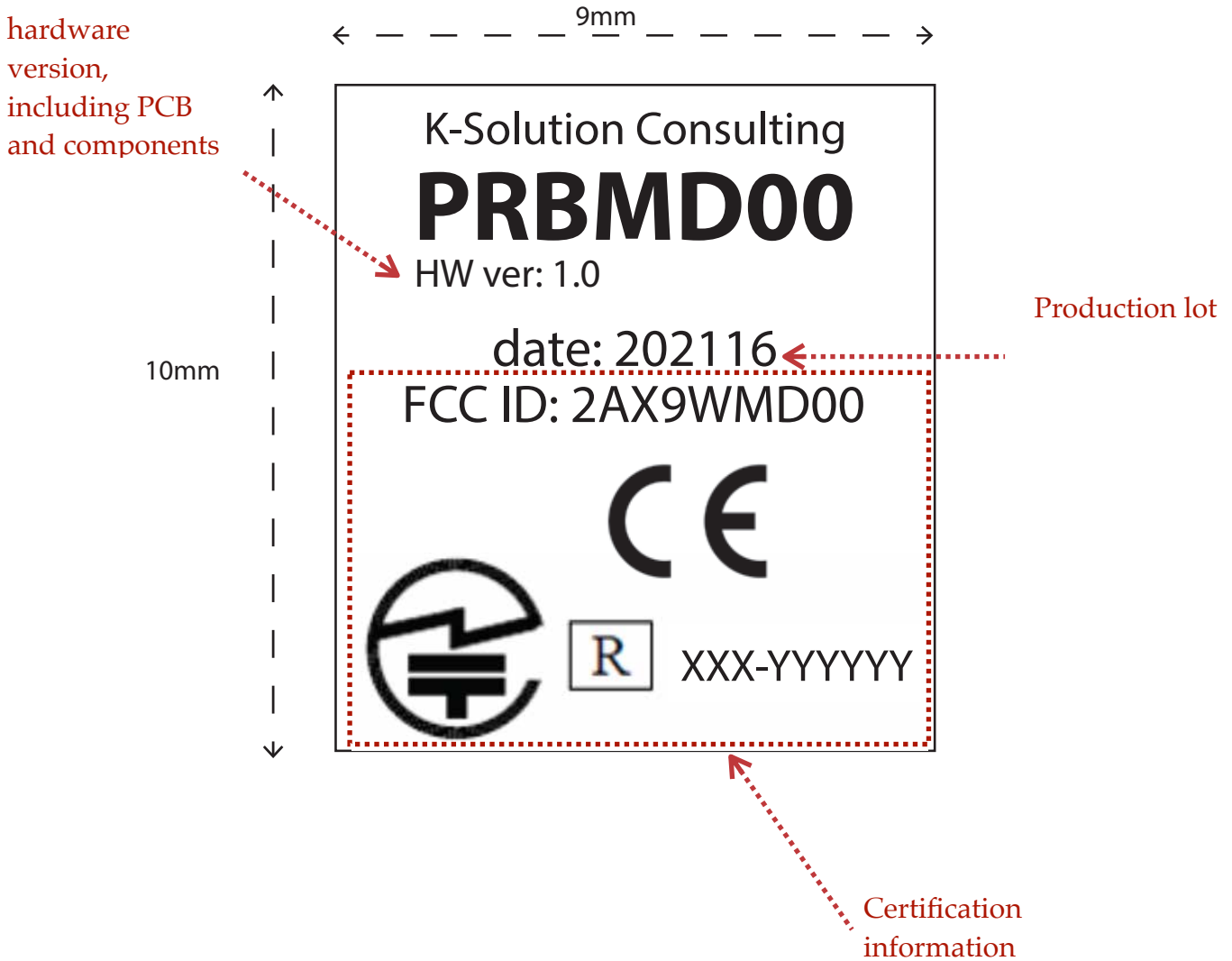

Note: label design may be update and modified if needed

Package

Standard package of PRBMD00 is anti-electro static plastic tray, where each tray should be able to contain 85 pcs PRBMD00. Dimension of each tray is 15 x 30mm.



Note: package format is subject to change in order to enhance the efficiency

PRBMD0x module comparison

	PRBMD00	PRBMD01	PRBMD02	PRBMD12
Core chip	PHY6212	PHY6212	PHY6222	PHY6222
MCU core	M0	M0	M0	M0
RAM (Byte)	138K	138K	64K	64K
FLASH (Byte)	512K	512K	128K	128K
Cache (Byte)	0	0	8K	8K
SDK	available	available	available	available
BT ver	5.1	5.1	5.1	5.1
Metal shielding	✓	✗	✓	✗
MESH	✓	✓	✓	✓
Audio	✓	✗	✗	✗
GPIO	33	19	19	19
Antenna	chip	chip	chip	PCB
32768Hz OSC	external	external	external	external
main clock	16MHz	16MHz	16MHz	16MHz
Tx power max	10dBm	10dBm	10dBm	10dBm
Sensitivity @1M	-97dBm	-97dBm	-97dBm	-97dBm
Operating current	670uA	670uA	460uA	460uA
Idle current	0.7uA	0.7uA	0.3uA	0.3uA
Operating voltage	3.3-6V	1.8-3.6V	1.8-3.6V	1.8-3.6V
Certification	FCC, CE, TELEC	N/A	FCC. CE. TELEC	TBC
Status	in production	Build-to-order	designing	planning

Revision History

2020-04-20	version 0.9
2020-08-17	version 1.1 AT-CMD list updated
2020-08-28	version 1.2 Current consumption test result added
2020-10-07	EVK information updated
2020-12-02	version 1.4 Adding package and label information Adding Conformity
2020-12-04	version 1.5 Adding RED conformity
2020-12-15	version 1.6 Adding certification copy
2021-01-06	version 1.65 Update part number
2021-02-24	version 1.70 updated electrical spec. correct pin number in diagram update package information

Reference

ADC Application Note
ANCS Application Note
Font Application Note
GPIO Application Note
OTA Note
SDK Application Guide
MESH Application Guide
KATP product brief

Contact information

Head quarter:

K-Solution Consulting Co. Ltd.

web: www.k-sol.com.hk

Tel: +852-91983405

Fax: +852 3013 8763

E-mail: sales@k-sol.com.hk